

KENWOOD

KAC-PS500F

4-CHANNEL POWER AMPLIFIER ▶ Page 2-13

INSTRUCTION MANUAL

AMPLIFICATEUR DE PUISSANCE 4 CANAUX ▶ Page 14-25

MODE D'EMPLOI

AMPLIFICADOR DE POTENCIA DE 4 CANALES ▶ Page 26-37

MANUAL DE INSTRUCCIONES

KENWOOD CORPORATION

**Take the time to read through this instruction manual.
Familiarity with installation and operation procedures will help
you obtain the best performance from your new power amplifier.**

For your records

Record the serial number, found on the back of the unit, in the spaces designated on the warranty card, and in the space provided below.

Refer to the model and serial numbers whenever you call upon your KENWOOD dealer for information or service on the product.

Model KAC-PS500F Serial number _____

Safety precautions

▲WARNING

Take the following precautions to prevent fire and avoid personal injury :

- When extending the battery cable, or ground cable, use 5mm² (AWG10) or larger automotive grade cable to avoid cable deterioration or damage to the covering.
- Check that no metal objects (coins, tools, etc.) are left inside the unit to avoid short circuits.
- If you smell or see smoke, turn the power off immediately and consult your Kenwood dealer.
- Do not touch the unit during use because the surface of the unit becomes hot and may cause burns if touched.

▲CAUTION

Take the following precautions to keep the unit in proper working order.

- Be sure the unit is connected to a 12V DC power supply with a negative ground connection.
- Do not open the top or bottom cover.
- Do not install the unit in places it is exposed to direct sunlight, high heat or humidity, water may splash over it, or dust exists.

NOTE

- If you have difficulty in installing this unit in your vehicle, contact your Kenwood dealer.

Cleaning the unit

- If the surface is dirty, wipe it clean with a silicon cloth or soft dry cloth with the power off.



▲CAUTION

Do not use hard cloths or paint thinner, alcohol, or other volatile solvents. These may damage external surfaces or remove indicator characters.

FCC WARNING

This equipment may generate or use radio frequency energy. Changes or modifications to this equipment may cause harmful interference unless the modifications are expressly approved in the instruction manual. The user could lose the authority to operate this equipment if an unauthorized change or modification is made.

Accessories

Part name	External View	Number of Items
Self-tapping screws (ø5 × 18mm)		6
Terminal cover (Power terminal)		1

Installation procedure

Since there are large variety of settings and connections possible according to applications, read the instruction manual well to select the proper setting and connection.

1. Remove the ignition key and disconnect the negative \ominus terminal of the battery to prevent short circuits.
2. Set the unit according to the intended usage.
3. Connect the input and output cables of the units.
4. Connect the speaker cables and sigma servo feed back cables.
5. Connect the power cable, power control cable and grounding cable following this order.
6. Install the unit in the car.
7. Connect the negative \ominus terminal of the battery.

⚠CAUTION

- If sound is not output normally, immediately turn power off and check connections.
- Be sure to turn the power off before changing the setting of any switch.
- If the fuse blows, check cables for shorts, then replace the fuse with one of the same rating.
- Check that no unconnected cables or connectors are touching the car body. Do not remove caps from unconnected cables or connectors to prevent short circuits.
- Connect the speaker cables to appropriate speaker connectors separately. Sharing the negative cable of the speaker or grounding speaker cables to the metal body of the car can cause this unit to fail.
- After installation, check that the brake lamps, wipers, and wipers work properly.

Installation

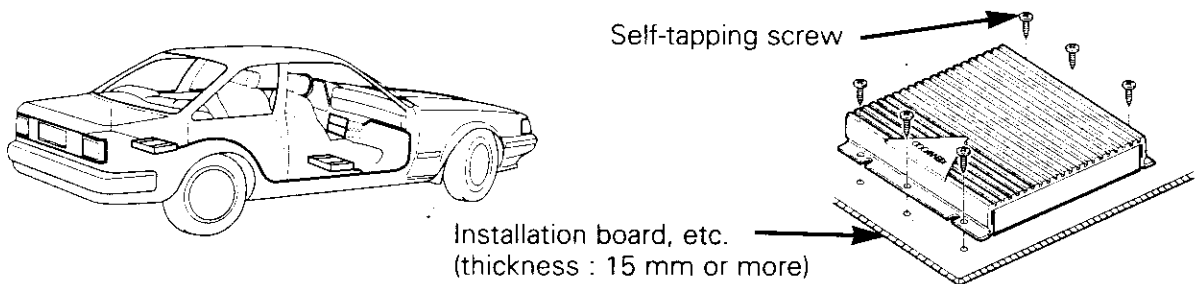

- Since the power amplifier has no parts which require operation, it can be installed at a position away from the driver's seat without any hindrances. As generally accepted positions for its installation, places such as inside the trunk, etc. can be considered.
- Use the extension cables. (Optional.)

Type \ Length	0.5m	1m	2m	4m	5m	6m
RCA cable	CA-2SL	CA-12SL	CA-22SL	—	CA-52SL	—
RCA cable (ø7mm)	CA-3WL	CA-13WL	CA-23WL	—	CA-53WL	—
RCA cable (ø12mm)	CA-5W	CA-15W	CA-25W	CA-45W	—	CA-65W

⚠CAUTION

- Do not install the unit under the carpet. Otherwise heat build-up occurs and the unit may be damaged.
- Install this unit in a location which allows heat to easily dissipate. Once installed, do not place any object on top of the unit.
- This unit has cooling fans to decrease the internal temperature. Be careful not to block the cooling fan openings when installing the unit. Blocking these openings will inhibit the cooling of the internal temperature and result in malfunction.
- After installing the unit, check to make sure that electrical equipment such as the brake lamps, turn signal lamps and windshield wipers operate normally.
- Install the unit securely in a location that does not interfere with driving.

Controls

This is a 4 channel amplifier including 2 stereo amplifiers in a body. One amplifier is referred to as amplifier A and the other is amplifier B. This unit is compatible with a large variety of systems by combining the switches and functions described in the following.

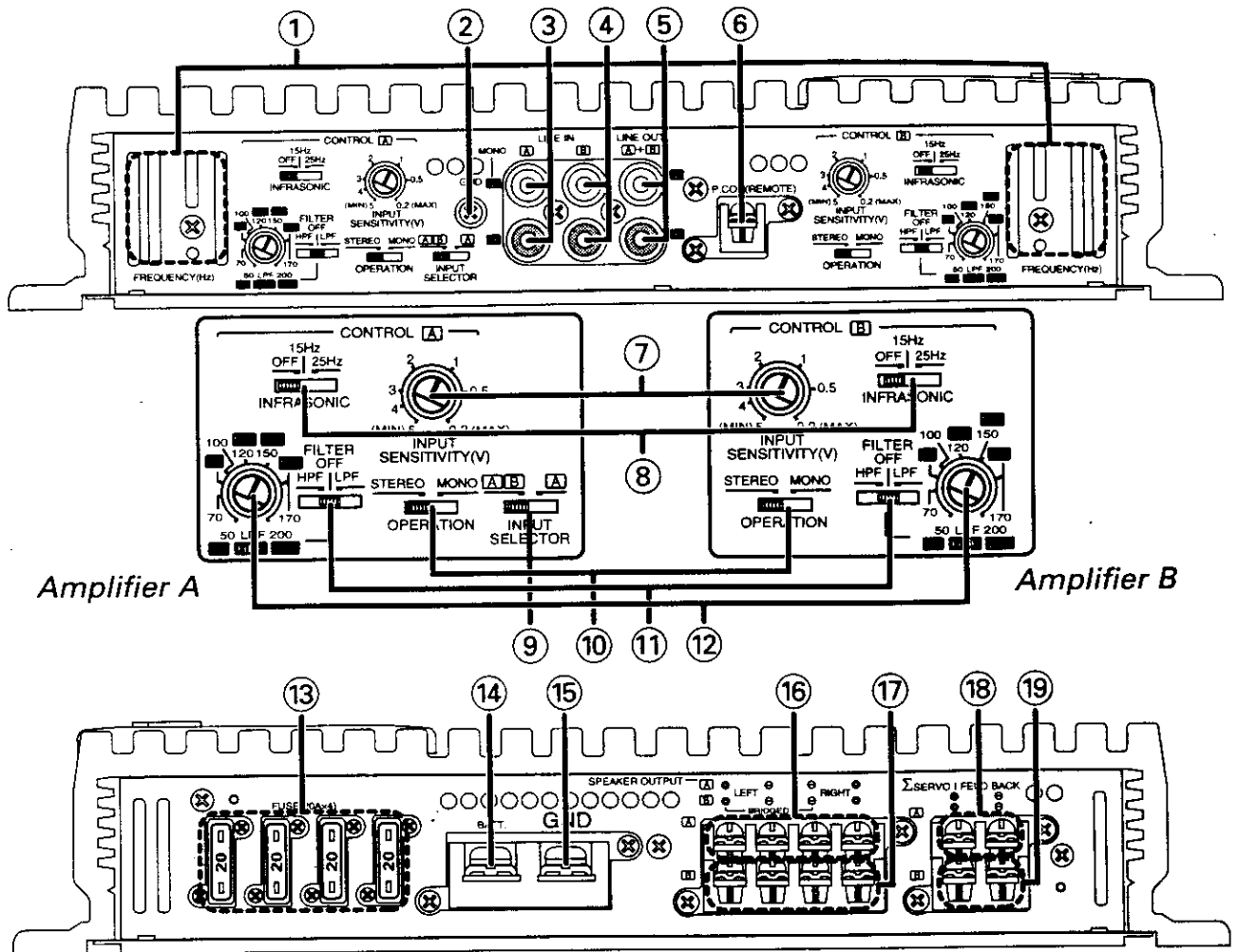

① Cooling fans

When the internal temperature of the amplifier rises, the cooling fans are activated automatically to drop the temperature. In certain situations, the cooling fans may be operating from the beginning of the amplifier operation.

② RCA cable ground lead terminal

③ Amplifier A LINE IN terminal

④ Amplifier B LINE IN terminal

⑤ LINE OUT terminal

These jacks output respectively the signals input to amplifiers A and B. They always output the stereo signals regardless of the position of the OPERATION switch.

⑥ Power control (REMOTE) terminal

⑦ INPUT SENSITIVITY control

Adjust this control according to the pre-out level of the center unit connected to this amp.

The sensitivities of amplifiers A and B can be adjusted independently regardless of the position of the input selector.

NOTE

Refer to "Specifications" on the center unit's instruction manual about the pre-out level.

⑧ INFRASONIC FILTER FREQUENCY switch

When this switch is set to 15 Hz or 25 Hz, frequencies below the setting value will be cut. This serves to get rid of unwanted

vibrations that do not result in sound and improves the speakers' ability to reproduce sound. Note that the speaker output will automatically be set for monaural (L+R) sound.

⑨ **INPUT SELECTOR switch**

This switch selects the input method of the signals to be amplified by amplifiers A and B.

- **A B position:**
Amplifies both of the signals input to amplifiers A and B.
- **A position:**
Amplifies only signal input amplifier A with both amplifiers A and B.

⑩ **OPERATION switch**

The amplification methods of the signals input to amplifiers A and B can be selected independently according to the setting of this switch.

- **STEREO position:**
The amplifier can be used as a stereo amplifier.
- **MONO (Lch) position:**
Amplifies the signal input from the left side only. Set to this position and make bridged connections to use as a high-power monaural amplifier. (The input right signal is not output.)

⑪ **FILTER switch**

This switch allows to apply high-pass or low-pass filtering to the speaker outputs.

- **HPF (High-Pass Filter) position:**
The filter outputs the band of higher frequencies than the frequency set with the HPF FREQUENCY control.
- **OFF position:**
The entire bandwidth is output without filtering.
- **LPF (Low-Pass Filter) position:**
The filter outputs the band of lower frequencies than the frequency set with the LPF FREQUENCY control.
The speaker output is automatically turned monaural (L+R) and the bass boost function is activated.

⑫ **FREQUENCY control**

When the FILTER switch is set to the HPF (High-Pass Filter) or LPF (Low-Pass Filter) position, the threshold frequency can be adjusted with this control.

⑬ **Fuse (20 A × 4)**

⑭ **Battery terminal**

⑮ **Ground terminal**

⑯ **Amplifier A speaker output terminals**

⑰ **Amplifier B speaker output terminals**

❖ **SPEAKER OUTPUT terminals**

• **Stereo Connections:**

When you wish to use the unit as a stereo amplifier, stereo connections are used.

The speakers to be connected should have an impedance of 2Ω or greater. When multiple speakers are to be connected, ensure that the combined impedance is 2Ω or greater for each channel.

• **Bridged Connections:**

When you wish to use the unit as a high-output monaural amplifier, bridged connections are used. (Make connections to the LEFT channel (+) and the RIGHT channel (-) SPEAKER OUTPUT terminals.) The speakers to be connected should have an impedance of 4Ω or greater. When multiple speakers are to be connected, ensure that the combined impedance is 4Ω or greater.

CAUTION

The rated input of the speakers should be no less than the maximum output of the amplifier. Otherwise malfunction may result.

⑱ **Amplifier A SIGMA SERVO I FEED BACK terminals (See p.7)**

⑲ **Amplifier B SIGMA SERVO I FEED BACK terminals (See p.7)**

CAUTION

The SIGMA SERVO FEEDBACK terminals should be connected properly. Failure to connect them properly will be the cause of breakdown.

Power indicator

■ Power indicator:

This lamp indicates the status of the unit, including the power supply and protection function, by lighting in red, amber or green or turning off.

When power is turned ON, it lights in green for a few seconds, then turns red when normal operation starts.

Power indicator

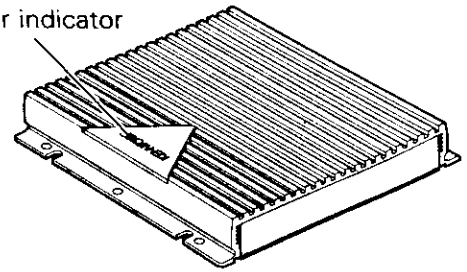

■ The protection function is activated in the following situations:

This unit incorporates a protection function which protects the main unit and speakers from troubles. The unit stops to function when the protection function is activated.

• If the POWER INDICATOR lights in green:

- A speaker cable may be short-circuited.
- A speaker output may be in contact with the ground.
- The temperature of the internal parts may be higher than 120°C (248°F)
- The sigma servo connection may be erroneous.
- The fuse of this unit may be blown.
- The unit may be malfunctioning and sending DC signal to the speaker output.

• If the POWER INDICATOR does not light up:

- The grounding cable of this unit may not be connected with a metallic part which is electrically connected with the negative terminal of the battery.
- The power control cable may not be connected to this unit.
- The grounding cable of the center unit (cassette receiver, CD receiver, etc.) may not be connected with a metallic part which is electrically connected with the negative terminal of the battery.
- The fuse of this unit may be blown.

■ Drop in supply voltage (If the POWER INDICATOR lights or blinks in amber):

When the power supply voltage drops below 11.5 V, the POWER INDICATOR lights in amber. If the POWER INDICATOR blinks or lights in amber, check the following items and make sure to supply enough power to this unit.

- Is the battery cable too thin to supply enough power?
- Is the battery cable deteriorated?
- Is the battery exhausted?

▲ CAUTION

Do not use thin or deteriorated cables for this may cause heat generation or burn. The cable used should be thick enough (5 mm² or more) to supply power.

Combined Impedance

Refer to the diagrams below and ensure that the combined impedance is 2Ω or greater for stereo connections and 4Ω or greater for bridged connections.

■ Basic connection

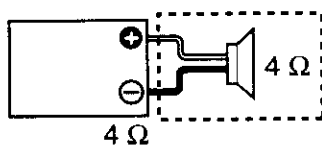

■ Series connection

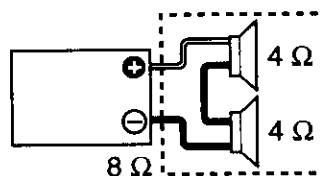

■ Parallel connection

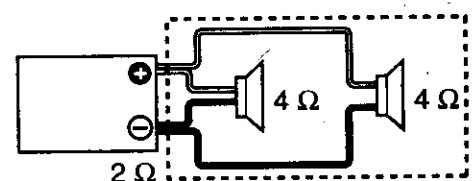

Sigma servo feed back

The sound reproduced through conventional amplifiers is distorted due to the counterelectromotive force produced in the oscillating system of the speaker. The counterelectromotive force is particularly high with the woofer which requires a large drive mass. The sigma servo connection reduces distortion caused by the counterelectromotive force by including the circuit up to the speaker terminals in the negative feedback loop. This makes it possible to drive speakers with more fidelity to the input signals and create a sharp bass sound image with few feeling of noise interference.

The aforementioned effects will not be obtained when the sigma servo connection has not been made.

NOTE

The speaker cable and the sigma servo cable should be wired to run along the same route. Note that this wiring should be separated from the power supply cable.

CAUTION

- The SIGMA SERVO FEEDBACK terminals should be connected properly. Failure to connect them properly will be the cause of breakdown.
- The rated input of the speakers connected to this unit should be no less than the maximum output of the amplifier. Otherwise malfunction may result.
Be specially careful in this when connecting speakers in a parallel configuration.
- Speakers that are to be used for bridged connections to this unit should have an impedance of 4Ω or greater. When connecting multiple speakers, ensure that the combined impedance is 4Ω or greater. Connection of speakers of less than 4Ω will be the cause of breakdown.

Basic sigma servo connection

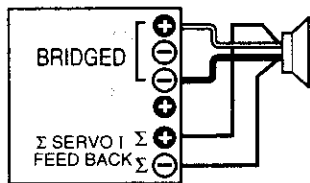

Series connection

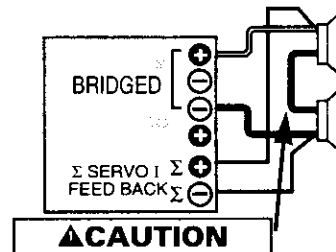

CAUTION

Make this cable as short as possible.

Parallel connection (1)

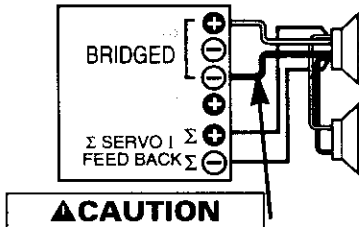

CAUTION

The speaker cables connected to this unit should be thick enough to supply the current capacity of two speakers.

Parallel connection (2)

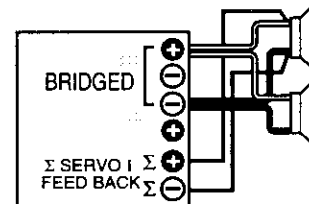

CAUTION

This connection is possible only when the speakers are identical and the speaker cables are also of the same type and length.

Stereo Connections When the Aforementioned Connections Are Not Possible

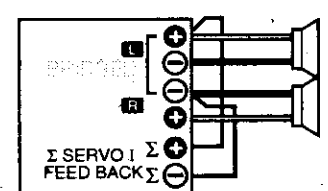
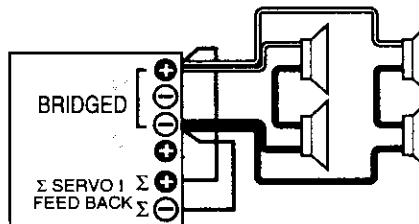
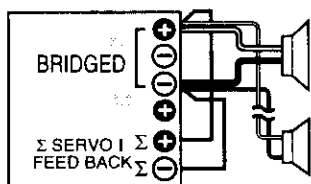

Connection

■ Power and Speakers cable connection (Stereo Connections)

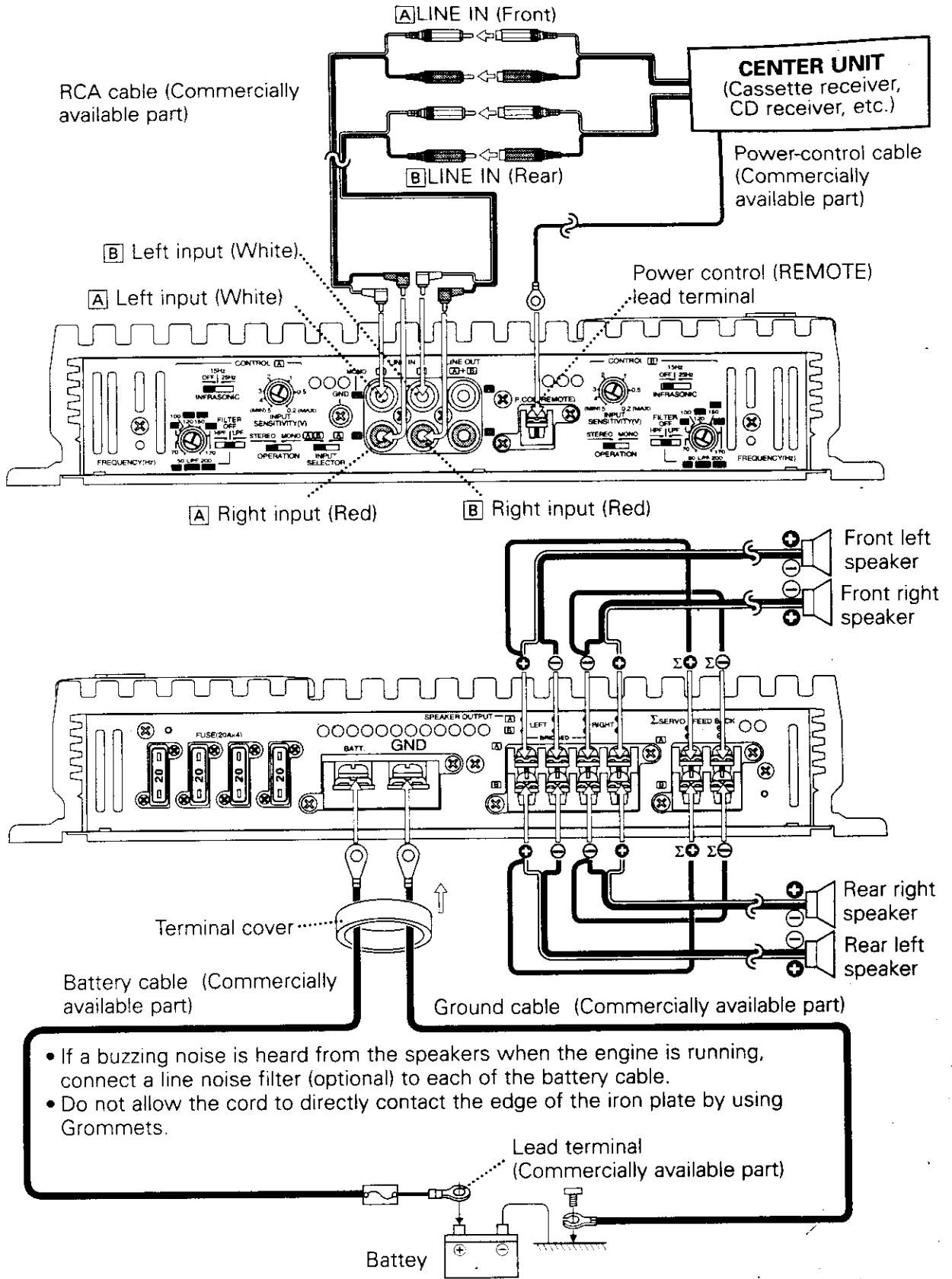

■ Bridged Connections

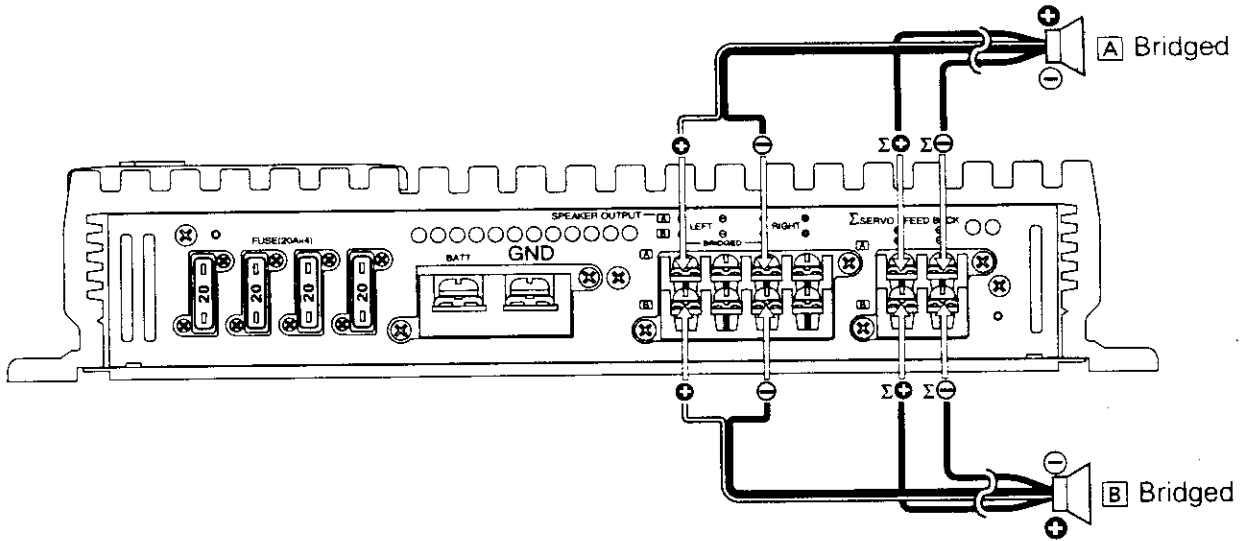

■ Connection Precautions

▲WARNING

To prevent fire caused by a short in the wiring, connect a fusible link or breaker nearby the battery's positive terminal.

NOTE

Connect the ground cable to a metal part of the car chassis that acts as an electrical ground passing electricity to the battery's negative \ominus terminal. Do not turn the power on if the ground cable is not connected.

Power terminal

Pass battery and ground cables through supplied terminal cover and connect to respective terminals. After completing connections, fasten terminal cover over terminal bracket.

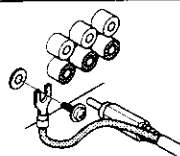
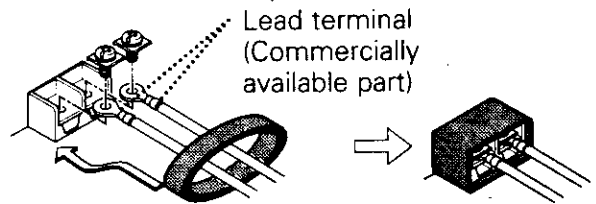

RCA cable ground terminal

When using an RCA cable with a ground lead attached, connect the ground lead to this terminal.

▲CAUTION

Do not use this terminal for power source grounding. This unit will be damaged if the power source grounding wire is connected to this terminal.

Power control lead terminal

Connect the Center unit's power control lead from the center unit.

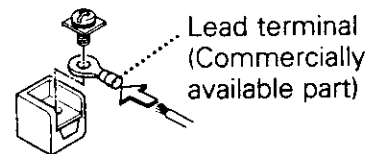

Speaker Output/Sigma Servo Feedback Terminals

Connect the speaker output cables to these terminals.

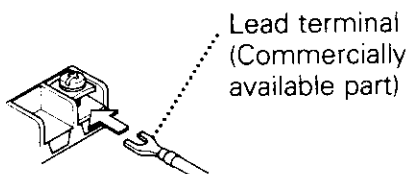

▲CAUTION

- Speakers that are to be used for stereo connections to this unit should have an impedance of 2Ω or greater. When connecting multiple speakers, ensure that the combined impedance is 2Ω or greater. Connection of speakers of less than 2Ω will be the cause of breakdown.
- Speakers that are to be used for bridged connections to this unit should have an impedance of 4Ω or greater. When connecting multiple speakers, ensure that the combined impedance is 4Ω or greater. Connection of speakers of less than 4Ω will be the cause of breakdown.

System examples

By combining the switches and functions of the KAC-PS500F, you can implement a wide range of audio system configurations.

■ Full-range 4-channel + Subwoofer system

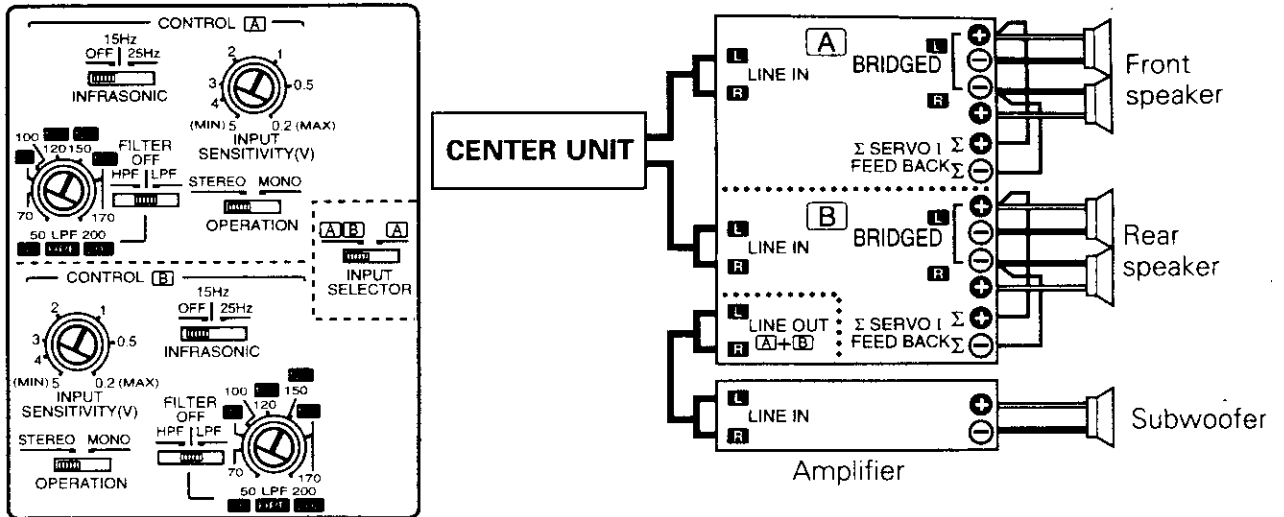

■ High-pass (100 Hz) + Subwoofer (100 Hz) system

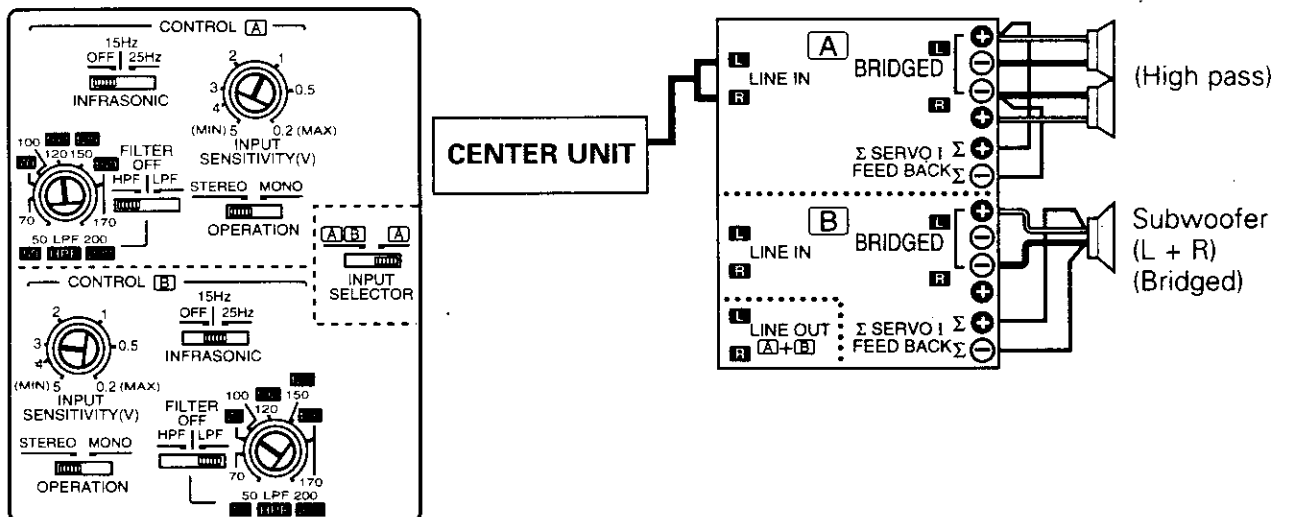

■ High-power 2-channel system

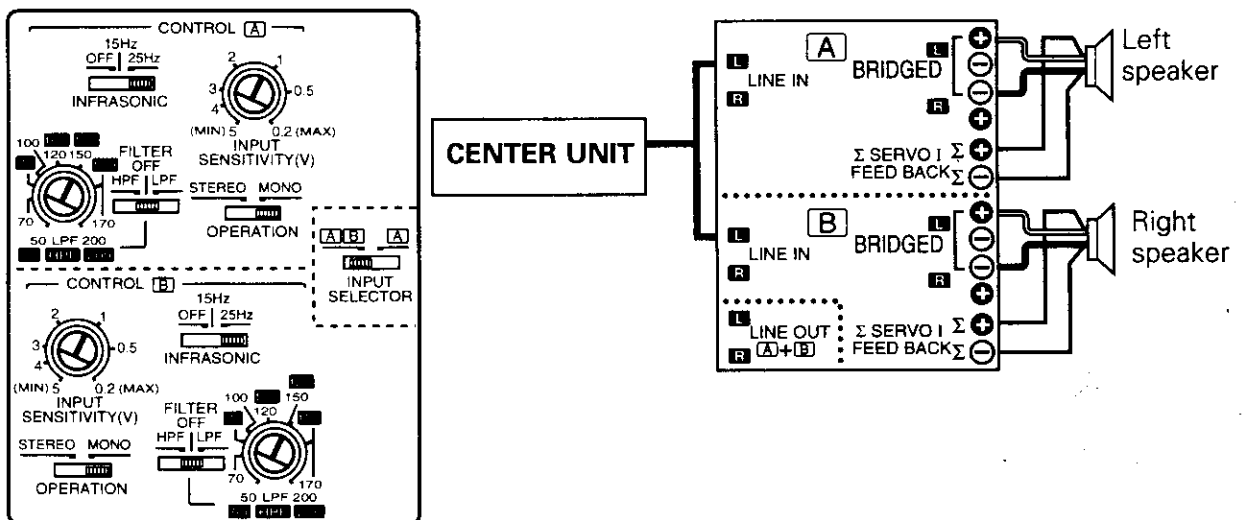

■ Tri-mode

With the KAC-PS500F, a subwoofer can be added easily to the speaker system by marking use of the properties of coils and capacitors. This mode of operation is called Tri-mode.

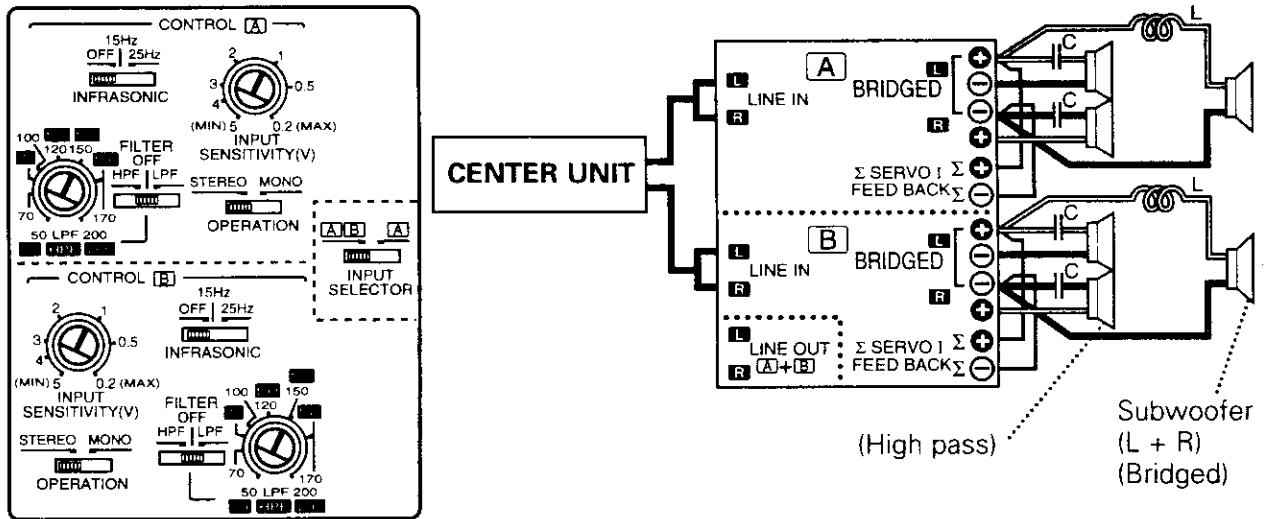

● Principle of Tri-mode

Method of frequency band division using a coil and capacitor---in case of 6dB/oct. slope

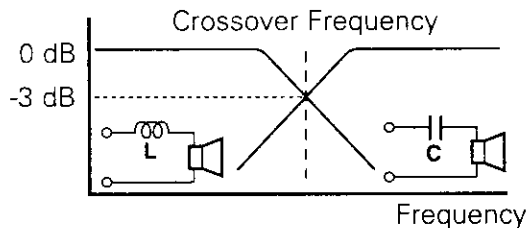

Coil (L): Passes low frequencies and blocks high frequencies. (Low pass)

Capacitor (C): Passes high frequencies and blocks low frequencies. (High pass)

$$C = \frac{159000}{f_c \times R} (\mu\text{F})$$

$$L = \frac{159 \times R}{f_c} (\text{mH})$$

$f_c = \text{Cut of Frequency (Hz)}$
 $R = \text{Speaker Impedance } (\Omega)$

● Example:

When it is required to set a crossover frequency of 120 Hz using speakers with an impedance of 4 ohms.

Prepare commercially-available coil and capacitor with the closest ratings to the results calculated from the formula above. The capacitor rating should be as close as possible to 331.25 (μF) and the coil rating should be as close as possible to 5.3 (mH).

▲ CAUTION

Be sure to connect a capacitor to the high-pass speaker. Failure to connect a capacitor will result in a drop of the combined impedance with the woofer.

Troubleshooting guide

Often, what appears to be a malfunction is due to user error. Before calling for service, please consult the following table.

Symptom	Cause	Remedy
No sound. (No sound from one side.)	<ul style="list-style-type: none">• Input (or output) cables are disconnected.• The connection of the sigma servo terminal is wrong.• Protection circuit may be activated.• The fuse may be blown because the volume was too high.	<ul style="list-style-type: none">• Connect the input (or output) cables.• Check the connection referring to "Sigma servo feedback".• Check connections by referring to "Power indicator".• Replace the fuse with a new fuse and use a lower volume.
The output level is too small (or too large).	The input sensitivity adjusting control is not set to the correct position.	Adjust the control correctly referring to "Controls".
The sound quality is bad. (The sound is distorted.)	<ul style="list-style-type: none">• The speakers cable are connected with wrong ⊕ / ⊖ polarity.• A speaker cable is pinched by a screw in the car body.• The switches may be set improperly.	<ul style="list-style-type: none">• Connect them properly checking the ⊕ / ⊖ of the terminals and cables well.• Connect the speaker cable again so that it is not pinched by anything.• Set switches properly by referring to "Controls" and "System examples".

Specifications

Specifications subject to change without notice.

Audio Section

Max Power Output (4 Ω)	
4 Channel Mode	150 W \times 4
3 Channel Mode	150 W \times 2 + 600 W \times 1
2 Channel Mode	600 W \times 2
Rated Power Output (4 Ω) (+B = 12.0 V)	
4 Channel Mode	50 W \times 4 (20 Hz ~ 20 kHz, 0.05 % THD)
3 Channel Mode	50 W \times 2 (1 kHz, 0.05 % THD) + 200 W \times 1 (1 kHz, 0.5 % THD)
2 Channel Mode	200 W \times 2 (1 kHz, 0.5 % THD)
Rated Power Output (2 Ω) (+B = 12.0 V)	
4 Channel Mode	100 W \times 4 (1 kHz, 0.5 % THD)
Rated Power Output (4 Ω) (+B = 14.4 V)	
4 Channel Mode	75 W \times 4 (20 Hz ~ 20 kHz, 0.05 % THD)
3 Channel Mode	75 W \times 2 (1 kHz, 0.05 % THD) + 300 W \times 1 (1 kHz, 0.5 % THD)
2 Channel Mode	300 W \times 2 (1 kHz, 0.5 % THD)
Rated Power Output (2 Ω) (+B = 14.4 V)	
4 Channel Mode	150 W \times 4 (1 kHz, 0.5 % THD)
Frequency Response (+0, -1 dB)	5 Hz ~ 50 kHz
Total Harmonic Distortion (Rated power)*	0.010 % (1 kHz)
Signal to Noise Ratio	110 dB
Sensitivity (rated output) (MAX)	0.2 V
(MIN)	5.0 V
Input Impedance	10 k Ω
Damping Factor	More than 1000 (at Σ connect)
Low Pass Filter Frequency (24 dB/oct.) (Variable)	50 ~ 200 Hz
High Pass Filter Frequency (12 dB/oct.) (Variable)	50 ~ 200 Hz
Infrasonic Filter Frequency (24 dB/oct.)	15 / 25 Hz

* Sensitivity = Mini., Through LPF (30 kHz)

General

Operating Voltage	12.0 V (11 ~ 16 V allowable)
Current Consumption (4 Ω , +B = 12.0 V, 10% THD)	42 A
Dimensions (W \times H \times D)	272 \times 58 \times 450 mm 10-11/16 \times 2-5/16 \times 17-11/16 in.
Weight	7.0 kg 15.4 lbs